

WWH60-108ATV3*

Megapixel Telecentric Lens

- Compact design with coaxial illumination options;
- Perfect image and supports all kinds of Mega camera;
- High contrast, low distortion, high resolution;
- Optional adjustable Iris for resolution and DOF control;
- Megapixel 'object side' telecentric lens with optional long working distance versions with over 500mm working distance.



Optical Specifications	
Magnification (x)	6
Working Distance (mm)	108
Max Sensor Size (Φmm)	11(2/3")
Aperture (F/#)	28.7
Telecentricity typical (max) (deg)	0.02
Distortion typical (max) (%)	0.01
NA	0.1
Resolution (μm)	3.4
Depth of Field (mm)	0.06

Field of View (mm × mm)	
1/2"(6.4x4.8)	1.1x0.8
1/1.8"(7.13x5.37)	1.2x0.9
2/3" IMX250/264 (8.45x7.1)	1.4x1.2
Mechanical Specifications	
Mount	C
Length (mm)	165.5
Coaxial Light	No
Iris	No

Notes:

1. Depth of Field is calculated value, this value could be used for imaging test, but to get sharp image in application, half of calculated value is suggested.

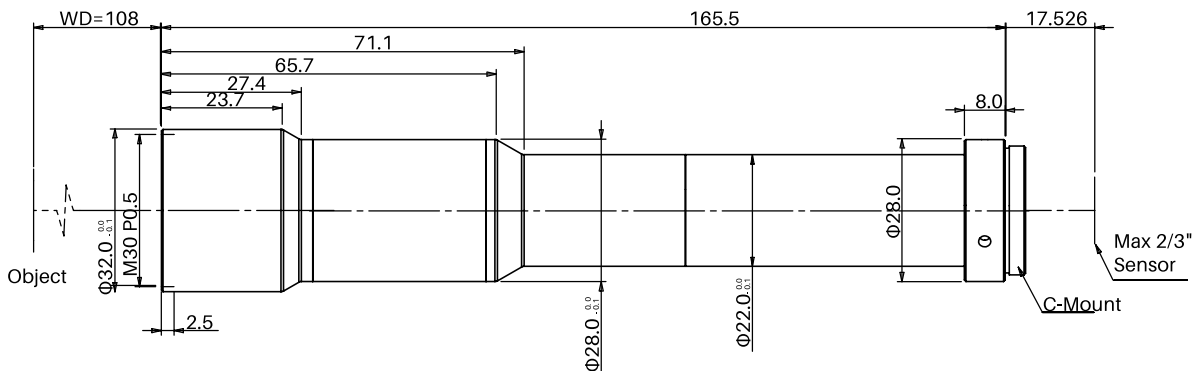

Note: * New product.