

MFA230-S08

8mm Focal Length

- Macro Designed For Machine Vision Application
- High Resolution, High Contrast, and Low Distortion
- Work with 1/3"-2/3" Format Camera and Focal Length is From 4mm to 100mm
- Perfect Substitute For FA Lens From Japan Like Tamron, CBC, VST, Ricoh ect

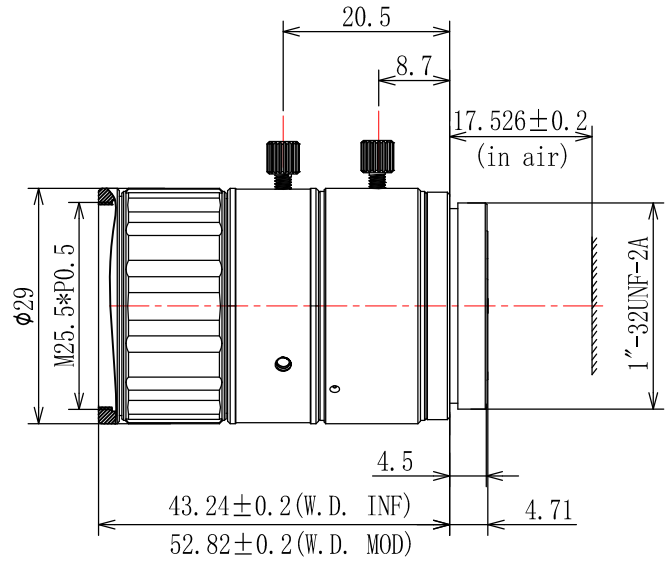

2/3" C-Mount				
Focal Length		f=8mm		
Max Diameter(RATIO)		F=2.6~16		
Picture Size		2/3"	1/1.8"	1/2"
Angle	H	53.5°	56.5°	42.0°
	V	46.0°	34.1°	32.1°
	D	67.2°	56.5°	51.4°
Distortion(TV)		<0.5%		
Focus distance(min)		0.11m		
Max sensor size		Φ11.4mm		
Filter screw size		M27*P0.5		
Mount		C-Mount		